

PLEASE CHECK WWW.MOLEX.COM FOR LATEST PART INFORMATION

Part Number: [0428789080](#)
Status: **Active**
Overview: [modular_plugs_jacks](#)
Description: Modular Jack, Vertical, Low Profile, 8/4, Panel Stops

Documents:

[3D Model](#) [Product Specification PS-42878 \(PDF\)](#)
[Drawing \(PDF\)](#) [RoHS Certificate of Compliance \(PDF\)](#)

Agency Certification

CSA LR19980
 UL E107635

General

Product Family Modular Jacks/Plugs
 Series [42878](#)
 Comments Flush Mount|Flangeless|2 PCB Thick
 Component Type PCB Jack
 Magnetic No
 Overview [modular_plugs_jacks](#)
 Performance Category 3
 Power over Ethernet (PoE) N/A
 Product Name RJ45

Physical

Boot Color N/A
 Color - Resin Black
 Durability (mating cycles max) 500
 Flammability 94V-0
 Inverted / Top Latch N/A
 Lightpipes/LEDs None
 Material - Metal Phosphor Bronze
 Material - Plating Mating Gold
 Material - Plating Termination Tin
 Material - Resin Polyester
 Orientation Vertical (Top Entry)
 PCB Locator Yes
 PCB Retention Yes
 PCB Thickness Recommended (in) 0.125 In
 PCB Thickness Recommended (mm) 3.18 mm
 Packaging Type Tray
 Pitch - Mating Interface (in) 0.040 In
 Pitch - Mating Interface (mm) 1.02 mm
 Pitch - Term. Interface (in) 0.050 In
 Pitch - Term. Interface (mm) 1.27 mm
 Plating min: Mating (µin) 50
 Plating min: Mating (µm) 1.25
 Plating min: Termination (µin) 100
 Plating min: Termination (µm) 2.5
 Ports 1
 Positions / Loaded Contacts 8/4
 Surface Mount Compatible (SMC) No
 Temperature Range - Operating -40°C to +85°C
 Termination Interface: Style Through Hole
 Waterproof / Dustproof No
 Wire/Cable Type N/A

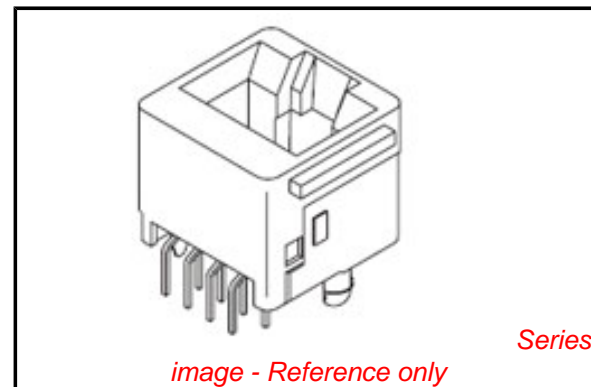

EU RoHS

**ELV and RoHS
 Compliant**
REACH SVHC
 Not Reviewed
**Halogen-Free
 Status**
 Not Reviewed

China RoHS



**Need more information on product
 environmental compliance?**

Email productcompliance@molex.com
 For a multiple part number RoHS Certificate of
 Compliance, [click here](#)

Please visit the [Contact Us](#) section for any
 non-product compliance questions.

Search Parts in this Series

[42878Series](#)

Mates With

FCC 68 Plugs

Electrical

Current - Maximum per Contact	1.5A
Shielded	No
Voltage - Maximum	150V AC (RMS)

Solder Process Data

Duration at Max. Process Temperature (seconds)	5
Lead-free Process Capability	Wave Capable (TH only)
Max. Cycles at Max. Process Temperature	1
Process Temperature max. C	235

Material Info**Reference - Drawing Numbers**

Packaging Specification	PK-42878-492
Product Specification	PS-42878
Sales Drawing	SDA-42878-****
Test Summary	TS-42878-001

This document was generated on 06/07/2010

PLEASE CHECK WWW.MOLEX.COM FOR LATEST PART INFORMATION

MODULAR JACK CHARACTERISTICS LEGEND	
EXTERNAL CONNECTOR BODY DIMENSIONS: (SEE NOTES 8 AND 9) JACKS ARE AVAILABLE IN STANDARD 4, 6, AND 8 POSITION BODY SIZES	
NUMBER OF CONTACT POSITIONS: CONNECTOR SIZE 4 CAN ACCOMMODATE 2 OR 4 TERMINALS, CONNECTOR SIZE 6 CAN ACCOMMODATE 2, 4, OR 6 TERMINALS, CONNECTOR SIZE 8 CAN ACCOMMODATE 2, 4, 6, 8, OR 10 TERMINALS	
POLARIZATION OPTION: "NO"= JACKS WITHOUT KEYING SLOT "YES"= JACKS WITH KEYING SLOT (AVAILABLE ON CONNECTOR SIZE 8 ONLY)	
MOUNTING EARS OPTION: "YES"= JACKS WITH MOUNTING EARS "NO"= JACKS WITHOUT MOUNTING EARS	

- NOTES:
- 1) MATERIALS: HOUSING- POLYESTER, GLASS FILLED, UL94V-0, COLOR - BLACK
TERMINALS- PHOSPHOR BRONZE ALLOY, .015/(0.38) THICK.
 - 2) TERMINAL PLATING:
SELECT GOLD IN CONTACT AREA: 50 MICRONS MIN.
*SELECT TIN IN PC TAIL AREA: 100 MICRONS MIN.
WITH OVERALL NICKEL UNDERPLATE: 50 MICRONS MIN.
*THE PRIMARY SHIPPING CARTON WILL BE LABELED "COMPLIANT TO ROHS DIRECTIVE 2002/95/EC AND ELV ANNEX II OF DIRECTIVE 2000/53/EC". CARTONS WITHOUT THIS LABEL MAY CONTAIN PRODUCT WITH TIN-LEAD IN THE PC TAIL.
 - 3) THESE MODULAR JACKS MEET THE PERFORMANCE REQUIREMENTS OF MOLEX PRODUCT SPECIFICATION PS-42878.
 - 4) CONNECTORS ARE SHIPPED IN THERMOFORMED TRAYS, PER PACKAGING SPECIFICATION PK-42878-492.
 - 5) ALL JACKS ARE DESIGNED TO BE USED WITH .062/(1.57) OR .125/(3.18) THICK P.C. BOARDS.
 - 6) ALL JACKS CONFORM TO AND ACCEPT PLUGS WHICH CONFORM TO FCC RULES AND REGULATIONS PART 68, SUBPART E.
 - 7) ALL JACKS MUST BE CAPABLE OF FITTING INTO MOLEX GAGE G-42410 (CONNECTOR SIZE 8).
 - 8) SEE SHEETS 1 & 4 FOR CONNECTOR SIZE 4.
 - 9) SEE SHEETS 2 & 4 FOR CONNECTOR SIZE 6.
 - 10) ENGRAVED NUMBERS ON HOUSING BODY ARE FOR MOLDING IDENTIFICATION ONLY, THEY ARE NOT INTENDED FOR ASSEMBLY IDENTIFICATION PURPOSES.
 - 11) THIS PART CONFORMS TO CLASS B REQUIREMENTS OF COSMETIC SPECIFICATION PS-45499-002 WITH THE EXCEPTION OF THE SINK WHICH CONFORMS TO CLASS C REQUIREMENTS.

P.C. BOARD THICKNESS	DIM. "D" (MTG. PEGS)	DIM. "F" (P.C. TAILS)
.062/(1.57)	.128 (3.25)	.120 +.015/-0.25 (3.05 +.38/-6.3)
.125/(3.18)	.191 (4.85)	.205 +.015/-0.25 (5.21 +.38/-6.3)

CONNECTOR SIZE	CIRCUIT SIZE	DIM. "G"
8	10	.450 (11.43)
8	8	.350 (8.89)
8	6	.250 (6.35)
8	4	.150 (3.81)
8	2	.050 (1.27)

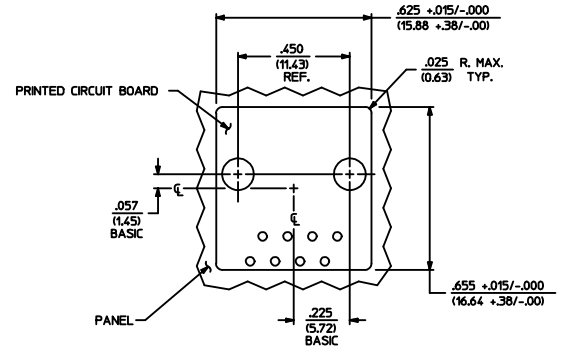
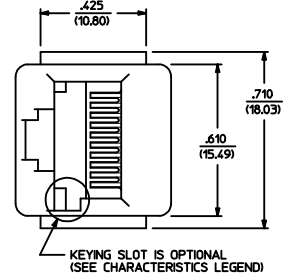

PANEL CUT-OUT FOR CONNECTOR SIZE 8

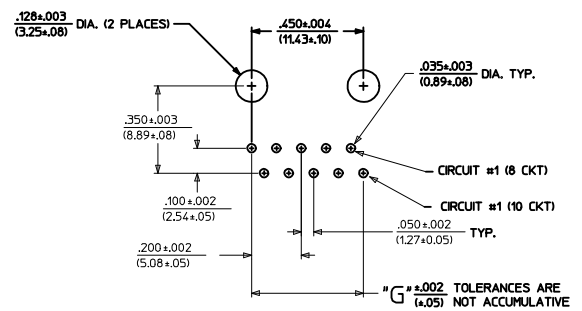
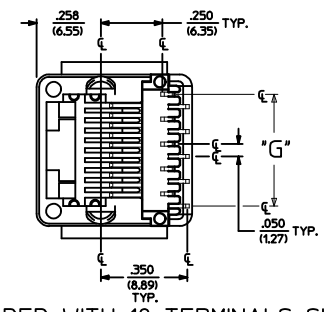
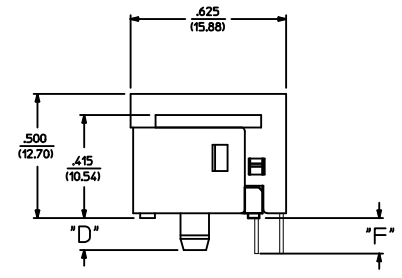
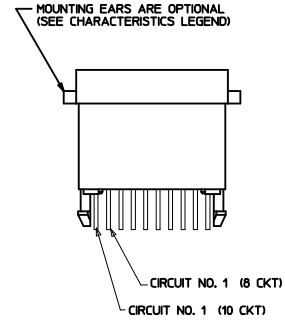

P.C. BOARD LAYOUT FOR CONNECTOR SIZE 8
10 CIRCUIT SHOWN

SIZE 8 MODULAR JACK LOADED WITH 10 TERMINALS SHOWN ABOVE

ADD COSMETIC SPEC EC NO. UCP2009-1267 H2	DRAWN: JKL/STENLER 2008/12/01 CHKD: BEL 2008/12/02 APPR: FSW/TH 2008/12/02	QUALITY SYMBOLS =0 =0	GENERAL TOLERANCES (UNLESS SPECIFIED)		DIMENSION STYLE		SCALE	DESIGN UNITS	THIRD ANGLE PROJECTION	TITLE ASSEMBLY, VERTICAL LOW PROFILE MODULAR JACKS (CONNECTOR SIZE 8)	MOLEX INCORPORATED	SHEET NO. 3 OF 5
			mm	INCH	IN/MM	1:1	INCH					
DRAWN WHERE APPLICABLE MUST REMAIN WITHIN DIMENSIONS			4 PLACES ± --- ± ---	BAP	DATE	1992/04/09						
			3 PLACES ± --- ± .010	CHECKED BY	DATE	1992/04/09						
			2 PLACES ± 0.25 ± ---	BAP	DATE	1992/04/09						
			1 PLACE ± --- ± ---	APPROVED BY	DATE	1992/04/09						
			ANGULAR ±1/2°	RAS	DATE	1992/04/09						
				MATERIAL NO.	DOCUMENT NO.	SDA-42878-****						
				SEE SHEET 5								
				THIS DRAWING CONTAINS INFORMATION THAT IS PROPRIETARY TO MOLEX INCORPORATED AND SHOULD NOT BE USED WITHOUT WRITTEN PERMISSION								

*X=NOT TOOLED	PART CHARACTERISTICS				
	ASSEMBLY ITEM NUMBER	EXTERNAL CONNECTOR SIZE	NUMBER OF POSITIONS	P. C. BOARD THICKNESS	POLARIZATION OPTION
42878-8408	8 POS. BODY	8	.062	NO	YES
42878-8410	↑	↑	↑	NO	NO
42878-8456	↑	↑	↓	YES	YES
42878-8458	↑	↑	.062	YES	NO
42878-8504	↑	↑	.125	NO	YES
42878-8506	↑	↑	↑	NO	NO
42878-8552	↑	↑	↑	YES	YES
42878-8554	8	8	.125	YES	NO
42878-8696	6	6	.062	NO	YES
42878-8698	↑	↑	↑	NO	NO
42878-8744	↑	↑	↓	YES	YES
42878-8746	↑	↑	.062	YES	NO
42878-8792	↑	↑	.125	NO	YES
42878-8794	↑	↑	↑	NO	NO
42878-8840	↑	↑	↓	YES	YES
42878-8842	8 POS. BODY	6	.125	YES	NO

*X=NOT TOOLED	PART CHARACTERISTICS				
	ASSEMBLY ITEM NUMBER	EXTERNAL CONNECTOR SIZE	NUMBER OF POSITIONS	BOARD THICKNESS/P.C. TAIL OPTION	POLARIZATION OPTION
42878-8984	8 POS. BODY	4	.062	NO	YES
42878-8986	↑	↑	↑	NO	NO
42878-9032	↑	↑	↓	YES	YES
42878-9034	↑	↑	.062	YES	NO
42878-9080	↑	↑	.125	NO	YES
42878-9082	↑	↑	↑	NO	NO
42878-9128	↑	↑	↓	YES	YES
42878-9130	4	4	.125	YES	NO
42878-9272	2	2	.062	NO	YES
42878-9274	↑	↑	↑	NO	NO
42878-9320	↑	↑	↓	YES	YES
42878-9322	↑	↑	.062	YES	NO
42878-9368	↑	↑	.125	NO	YES
42878-9370	↑	↑	↑	NO	NO
42878-9416	↑	↑	↓	YES	YES
42878-9418	8 POS. BODY	2	.125	YES	NO

*X=NOT TOOLED	PART CHARACTERISTICS				
	ASSEMBLY ITEM NUMBER	EXTERNAL CONNECTOR SIZE	NUMBER OF POSITIONS	BOARD THICKNESS/P.C. TAIL OPTION	POLARIZATION OPTION
42878-1001	8 POS. BODY	10	.062	NO	YES
42878-1003	↑	↑	.062	NO	NO
42878-1025	↑	↑	.125	NO	YES
42878-1027	↑	↑	↑	NO	NO
42878-1037	↑	↑	↓	YES	YES
42878-1039	8 POS. BODY	10	.125	YES	NO

CHARACTERISTICS LEGEND	
EXTERNAL CONNECTOR BODY DIMENSIONS: AVAILABLE IN 4, 6, AND 8 POSITION BODY	
NUMBER OF CONTACT POSITIONS: CONNECTOR SIZE 4 ACCOMMODATES 2, OR 4 TERMINALS, CONNECTOR SIZE 6 ACCOMMODATES 2, 4, OR 6 TERMINALS, CONNECTOR SIZE 8 ACCOMMODATES 2, 4, 6, 8, OR 10 TERMINALS	
POLARIZATION OPTION: (AVAILABLE ON CONNECTOR SIZE 8 ONLY) "NO" - WITHOUT KEYING SLOT "YES" - WITH KEYING SLOT	
MOUNTING EARS OPTION: "YES" - PART WITH MOUNTING EARS "NO" - PART WITHOUT MOUNTING EARS	
(SEE SHEET 3 FOR PART DESCRIPTIONS AND DIMENSIONS)	

SEE SHEET ONE EC NO: UCP2004-667 DRWN:LSCHMIDT 2004/03/03 CHKD:LSCHMIDT 2004/03/03 APPR:ESMITH 2004/03/03	QUALITY SYMBOLS	GENERAL TOLERANCES (UNLESS SPECIFIED)	SCALE	DESIGN UNITS	THIRD ANGLE PROJECTION	REVISE ON CAD ONLY
	▽ 0	mm INCH	---	INCH	TITLE	
	▽ 0	4 PLACES ± --- ± --- 3 PLACES ± --- ± --- 2 PLACES ± --- ± --- 1 PLACE ± --- ± ---	IN/MM	DRAWN BY DATE BAP 1992/04/09	ASSEMBLY, VERTICAL LOW PROFILE MODULAR JACKS (CONNECTOR SIZE 8)	
		ANGULAR ±1/2° DRAFT WHERE APPLICABLE MUST REMAIN WITHIN DIMENSIONS	CHECKED BY DATE BAP 1992/04/09	APPROVED BY DATE RAS 1992/04/09	MATERIAL NO. (DOCUMENT NO.) SEE CHART SDA-42878-****	SHEET NO. 5 OF 5
THIS DRAWING CONTAINS INFORMATION THAT IS PROPRIETARY TO MOLEX INCORPORATED AND SHOULD NOT BE USED WITHOUT WRITTEN PERMISSION						